

QUANTITY	MODEL NUMBER	NEXT ASSEMBLY	REVISIONS				
			ZONE	REV	DESCRIPTION	DATE	APPROVED
1	AV06XX-XX	0000		A	Initial Release	11/8/00	

+0.000
-0.000

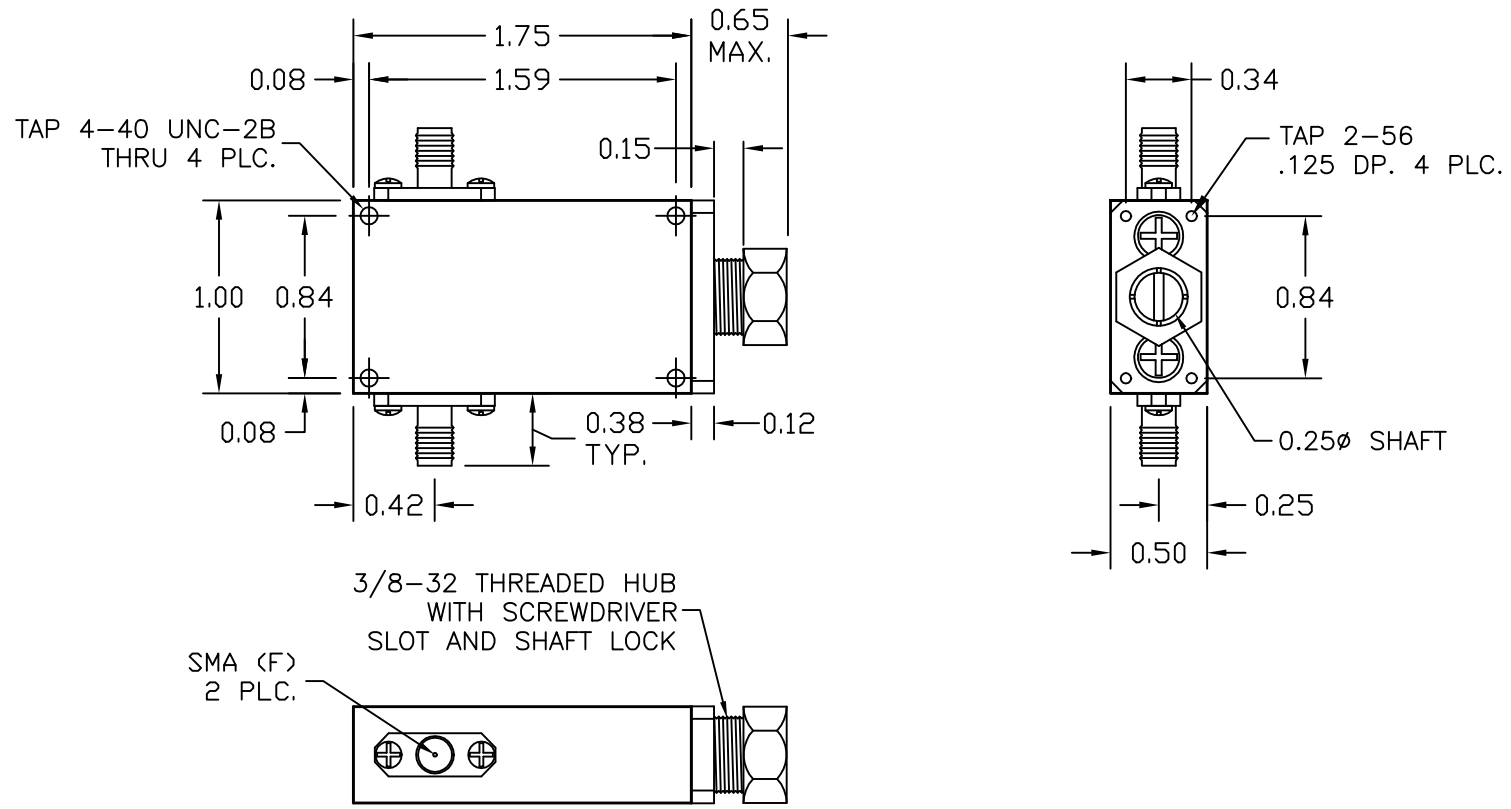

THIRD ANGLE PROJECTION =		DRAWN R. LYNCH	DATE 3/1/01	ADVANCED TECHNICAL MATERIALS, INC. 49 RIDER AVENUE, PATCHOGUE N.Y. 11772 TEL: (631) 289-0363 FAX: (631) 289-0358			
UNLESS OTHERWISE SPECIFIED DIMENSIONS ARE IN INCHES TOLERANCES ARE: FRACTIONS DECIMALS ANGELS ±1/64 ±.01 ±1/2°		PROPRIETARY NOTICE The information contained in this drawing is proprietary and shall not be used or disclosed without the prior written consent of ATM, Inc.		AV/AF06 ATTENUATOR			
MATERIAL		CHECKED		SIZE A	FSCM NO. OR8N4	DWG NO. 3020	REV A
FINISH		APPROVED		SCALE: 1 To 1		DO NOT SCALE DRAWING	SHEET 1 OF 3